

Corte A-A

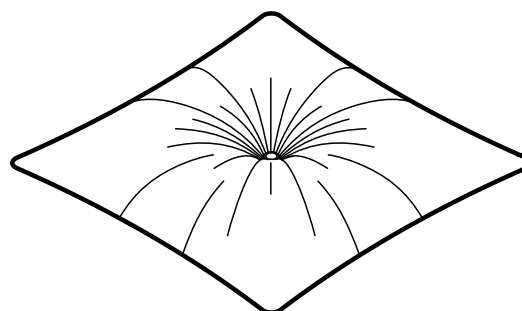

| | | | |
|--------|-------------|-------|---|
| 1 | Almohadón | 1 | Hormigón armado coloreado en toda su masa |
| Número | Descripción | Cant. | Observaciones |

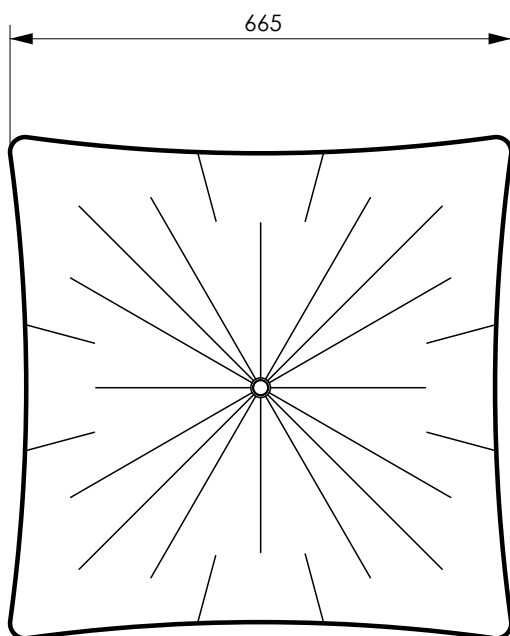
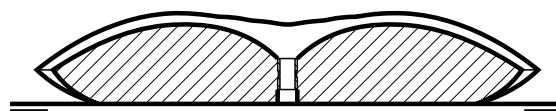

| | | |
|----------|-------|-------|
| Proyectó | Fecha | Firma |
| Dibujó | | |
| Revisó | | |
| Aprobó | | |

Escala:
1:10

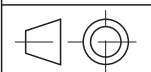

Formato
A4

Almohadón

Grupo Bondi

Capitoné urbano

Plano nro

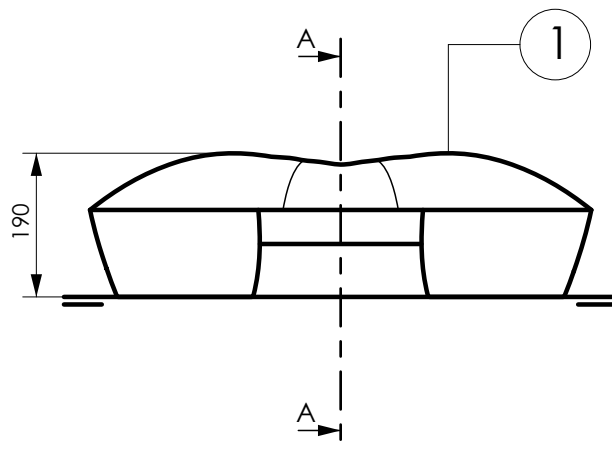

Corte A-A

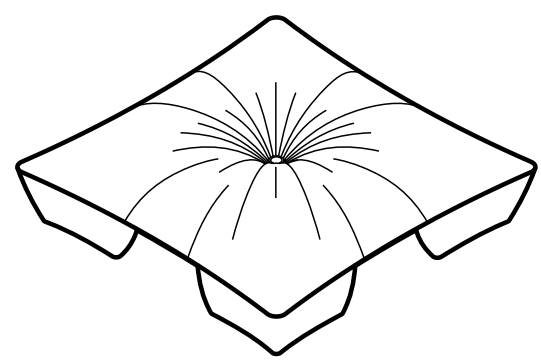
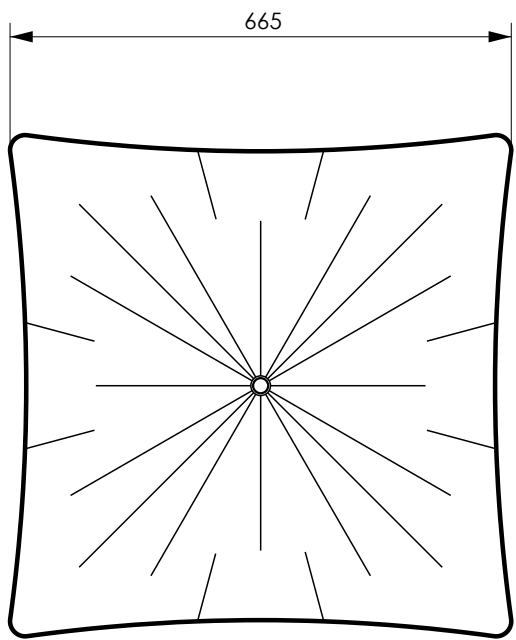
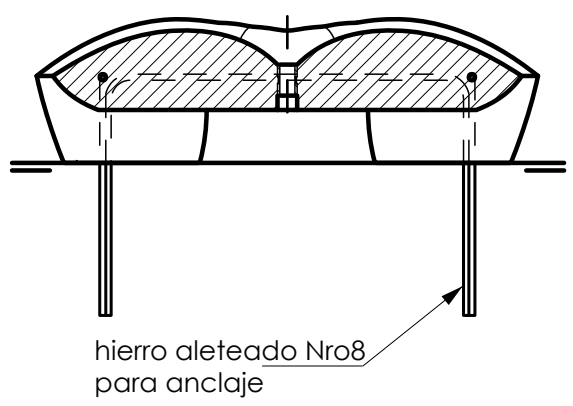

| 1 | Almohadón | 1 | Hormigón armado coloreado en toda su masa |
|--------|-------------|-------|---|
| Número | Descripción | Cant. | Observaciones |



| | | |
|----------|-------|-------|
| Proyectó | Fecha | Firma |
| Dibujó | | |
| Revisó | | |
| Aprobó | | |

| |
|-----------------|
| Escala: 1:10 |
| |
| Formato A4 |

Almohadón
con patas

| |
|-----------------|
| Grupo Bondi |
| Capitoné urbano |
| Plano nro |